

Vertex Standard

EVX-531 **OPERATING MANUAL**

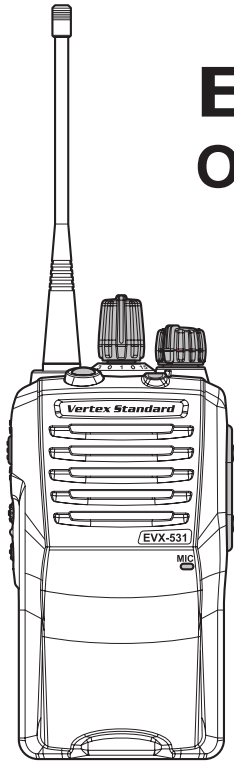

PROGRAMMABLE FUNCTIONS/FEATURES

- IP57 Submersible (1 m/30 min.)
 - 3 Programmable Function Keys
 - 2-Tone Encode/Decode*
 - MDC-1200® Encode/Decode*
 - Scan
 - Group Scan
 - Dual Watch
 - FM-Scan (Follow-Me Scan)
 - TA Scan
 - Privacy
 - VOX
 - Talk Around
 - Emergency
 - Lone Worker
 - TX Save Disable
 - ARTS™/ARTSII™ (Auto Range Transpond System)*
- *: Analog mode only

CONTENTS

Introduction	1	Operation	8
Warning! FCC RF Exposure Requirements	2	Preliminary Steps.....	8
Before You Begin	4	Operation Quick Start.....	8
Battery Pack Installation and Removal	4	Automatic Time-Out Timer	10
Battery Charging.....	4	Advanced Operation	11
Low Battery Indication.....	5	Programmable Key Functions	11
Belt Clip Installation and Removal	6	Description of Operating Functions	13
MIC/SP Cap Installation.....	6	Lock	19
Controls & Connectors	7	ARTS™/ARTSII™ (Auto Range Transpond System) ..	19
		Optional Accessories	20

Congratulations!

You now have at your fingertips a valuable communications tool, a Vertex Standard two-way radio! Rugged, reliable and easy to use, your Vertex Standard radio will keep you in constant touch with your colleagues for years to come, with negligible maintenance down-time. Please take a few minutes to read this manual carefully. The information presented here will allow you to derive maximum performance from your radio, in case questions arise later on.

Important Note

- There are no owner-serviceable parts inside the radio. All service jobs must be referred to an authorized Vertex Standard Service Representative.
- In order to maintain the specified water integrity performance, periodic maintenance is recommended.
- Should the radio sustain a severe shock (e.g. if it is dropped), the water integrity may be compromised, requiring service. Should this occur, contact your Authorized Vertex Standard Dealer.

INTRODUCTION

The **EVX-531** is full-featured Hand-Held Digital/Analog Transceiver designed for business communications in the VHF/UHF Land Mobile bands. This transceiver is designed for reliable business communications in a wide variety of applications with a wide range of operating capability provided by their leading-edge design.

The **EVX-531** allows up to 32-channel capacity within a maximum of 2 groups. Important channel frequency data is stored in the flash memory on the CPU, and is easily programmable by a Vertex Standard licensed dealers using a personal computer with Vertex Standard Programming equipment **FIF-12** USB Programming cable interface and **CT-106** Connection cable for **FIF-12** and **CE142** Software. Or, once programmed, cloning cable **CT-27** can be used to program portable to portable directly.

The pages which follow will detail the many advanced features provided in the **EVX-531** transceiver. After reading this manual, you may wish to consult with your Network Administrator regarding precise details of the configuration of this equipment for use in your application.

Important Notice for North American Users Regarding 406 MHz Guard Band

The U.S. Coast Guard and National Oceanographic and Atmospheric Administration have requested the cooperation of the U.S. Federal Communications Commission in preserving the integrity of the protected frequency range 406.0 to 406.1 MHz, which is reserved for use by distress beacons. Do not attempt to program this apparatus, under any circumstances, for operation in the frequency range 406.0 - 406.1 MHz if the apparatus is to be used in or near North America.

Warning - Frequency band 406 - 406.1 MHz is reserved for use ONLY as a distress beacon by the US Coast Guard and NOAA. Under no circumstance should this frequency band be part of the pre programmed operating frequencies of this radio.

WARNING! FCC RF EXPOSURE REQUIREMENTS

This Radio has been tested and complies with the Federal Communications Commission (FCC) RF exposure limits for Occupational Use/Controlled exposure environment. In addition, it complies with the following Standards and Guidelines:

- ❑ FCC 96-326, Guidelines for Evaluating the Environmental Effects of Radio-Frequency Radiation.
- ❑ FCC OET Bulletin 65 Edition 97-01 (2001) Supplement C, Evaluating Compliance with FCC Guidelines for Human Exposure to Radio Frequency Electromagnetic Fields.
- ❑ ANSI/IEEE C95.1-1992, IEEE Standard for Safety Levels with Respect to Human Exposure to Radio Frequency Electromagnetic Fields, 3 kHz to 300 GHz.
- ❑ ANSI/IEEE C95.3-1992, IEEE Recommended Practice for the Measurement of Potentially Hazardous Electro-magnetic Fields - RF and Microwave.

 **WARNING:**

This radio generates RF electromagnetic energy during transmit mode. This radio is designed for and classified as **Occupational Use Only**, meaning it must be used only during the course of employment by individuals aware of the hazards, and the ways to minimize such hazards. This radio is not intended for use by the General Population in an uncontrolled environment.

 **CAUTION:**

To ensure that your expose to RF electromagnetic energy is within the FCC allowable limits for occupational use, always adhere to the following guidelines:

- **This radio is NOT approved for use by the general population in an uncontrolled exposure environment. This radio is restricted to occupational use, work related operations only where the radio operator must have the knowledge to control his or her RF exposure conditions.**

WARNING! FCC RF EXPOSURE REQUIREMENTS

- **When transmitting, hold the radio in a vertical position with its microphone 2 inches (5 cm) away from your mouth and keep the antenna at least 2 inches (5 cm) away from your head and body.**
- **The radio must be used with a maximum operating duty cycle not exceeding 50%, in typical Push-to-Talk configurations.**

DO NOT transmit for more than 50% of total radio use time (50% duty cycle). Transmitting more than 50% of the time can cause FCC RF exposure compliance requirements to be exceeded. To keep the Body Worn configuration with the Vertex Standard CLIP-20 belt-clip, reduce the maximum operating duty cycle still more.

The radio is transmitting when the red LED on the top of the radio is illuminated. You can cause the radio to transmit by pressing the P-T-T button.
- **SAR compliance for body-worn use was only demonstrated for the specific belt-clip (CLIP-20). Other body-worn accessories or configurations may NOT comply with the FCC RF exposure requirements and should be avoided.**
- **When operate the radio with the Vertex Standard CLIP-20 belt-clip, make the transmission time as short as possible, to keep the Body Worn configuration.**
- **Always use Vertex Standard authorized accessories.**
- **The information listed above provides the user with the information needed to make him or her aware of RF exposure, and what to do to assure that this radio operates with the FCC RF exposure limits of this radio.**
- **Electromagnetic Interference/Compatibility**

During transmissions, this radio generates RF energy that can possibly cause interference with other devices or systems. To avoid such interference, turn off the radio in areas where signs are posted to do so. Do not operate the transmitter in areas that are sensitive to electromagnetic radiation such as hospitals, health care facilities, aircraft, and blasting sites.

BEFORE YOU BEGIN

Battery Pack Installation and Removal

- ❑ To install the battery pack, align the battery pack to the radio with an offset about 1/2 inch (1.5 cm) from the top edge of battery compartment, then slide the battery pack upward until it locks in place with a “Click.”

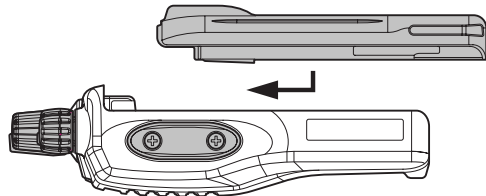

- ❑ To remove the battery, turn the radio off and remove any protective cases. Slide the Battery Pack Latch on the bottom of the radio toward the front panel while sliding the battery down about 1/2 inch (1.5 cm). Then lift the battery out from the radio.

 **Do not attempt to open any of the rechargeable Lithium-Ion packs, as they could explode if accidentally short-circuited.**

Battery Charging

- ❑ Remove the Spacer Plate from the nest of the optional **CD-58** Desktop Charger, if the Battery Spacer is installed.
- ❑ Insert the DC plug from the optional **PA-55** AC Adapter into the DC jack on the rear panel of the optional **CD-58** Desktop Charger, and then connect the **PA-55** AC Adapter to the AC line outlet.
- ❑ Insert the battery pack into the **CD-58** Desktop Charger while aligning the slots of the battery pack with the guides in the nest of the **CD-58**; refer to the following illustration for details on

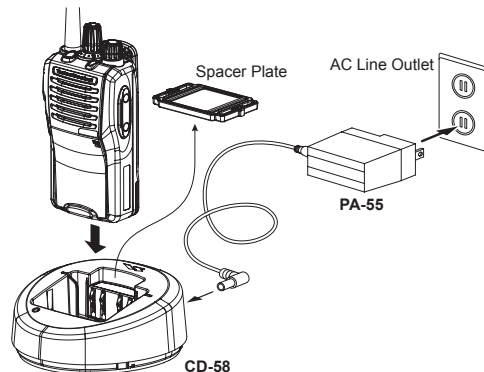

BEFORE YOU BEGIN

proper positioning of the battery pack. If charging with the transceiver attached, turn the transceiver off. The antenna jack should be at the left side when viewing the charger from the front.

- ❑ If the battery pack is inserted correctly, the LED indicator will glow red. A fully-discharged battery pack will charge completely in 1.5 - 3.0 hours (depending on the battery pack being charged).
- ❑ When charging is completed, the LED indicator will change to green.
- ❑ Disconnect the battery pack from the **CD-58** Desktop Charger and unplug the **PA-55** AC Adapter from the AC line outlet.



1) Always use the Vertex Standard FNB-V133LI-UNI or FNB-V134LI-UNI Lithium-Ion Battery Pack.

2) Use only the Vertex Standard CD-58 Desktop Charger and the Vertex Standard PA-55 AC Adapter.

3) To reduce the risk of explosion, recharge the batteries outside of hazardous locations.

4) Perform the battery charging where the ambient temperature range +41 °F to +104 °F (+5 °C to +40 °C). Charge out of this range could cause damage to the battery pack.

5) Battery Pack shall not be exposed to excessive heat such as sunshine, fire, or the like.

6) Risk of explosion if battery is replaced by an incorrect type. Dispose of used batteries according to the instructions

7) For further details and cautions of the charging, refer to the Operating Manual of the CD-58 Desktop Charger.

Low Battery Indication

As the battery discharges during use, the voltage gradually becomes lower. When the battery voltage becomes to low, substitute a freshly charged battery and recharge the depleted pack. The LED indicator on the top of the radio will blink red when the battery voltage is low.

CAUTION

Danger of explosion if battery is replaced with an incorrect battery. Replace only with the same or equivalent type.

BEFORE YOU BEGIN

Belt Clip Installation and Removal

- ❑ To install the Belt Clip: align the Belt Clip to the groove of the Battery pack, then press the Belt Clip downward until it locks in place with a “*Click.*”
- ❑ To remove the Belt Clip: use a flat head screw driver to press the Belt Clip Tab away from the battery pack to unlock the Belt Clip, then slide the Belt Clip upward to remove it.

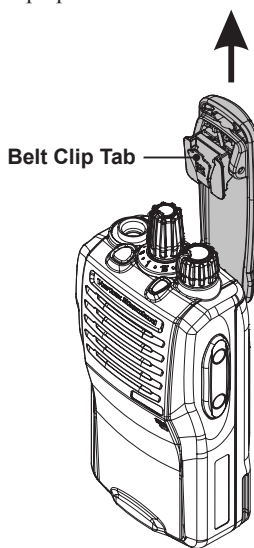
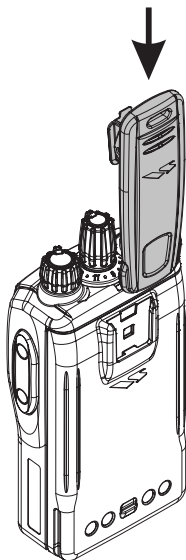

MIC/SP CAP Installation

Install the **MIC/SP** cap with the supplied screws.

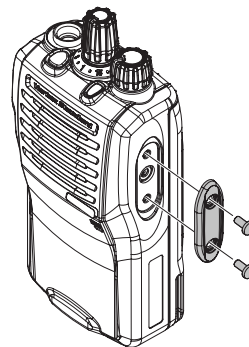

- ❑ Use only the supplied screws when install the **MIC/SP** cap.
- ❑ This radio does not keep the submersible Rating (IP57: 1 meter / 30 minutes) when the **MIC/SP** cap is not installed in the **MIC/SP** jack.

CONTROLS & CONNECTORS

VOL (Volume)/PWR (Power) Knob —

CH (Channel) Selector —

Antenna Jack —

TOP SEL (Top Select) Key —

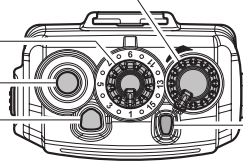

LED Indicator (Programmable)

Default settings are:

Steady Red:

Transmitting in progress (Analog)

Steady Blue:

Transmitting in progress (Digital)

Blinking Green:

Busy Channel

Steady Green:

Tone Squelch in defeated condition

PTT Switch —

SIDE-1 Button —

SIDE-2 Button —

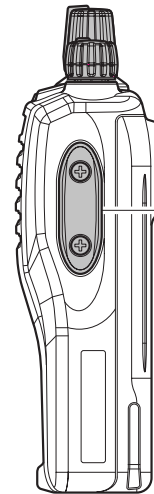
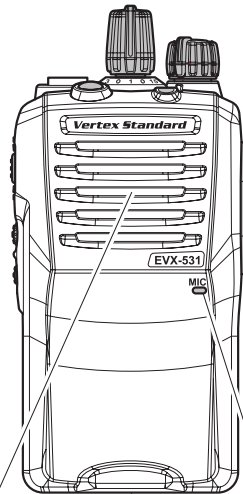
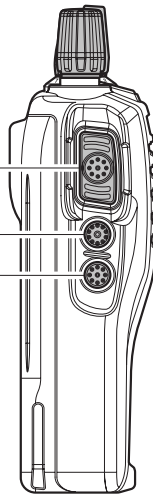

MIC/SP Jack
(External MIC/SP)

Speaker

Battery Pack Latch

Microphone

OPERATION

Preliminary Steps

- ❑ Install a charged battery pack onto the transceiver, as described previously.

- ❑ Screw the supplied antenna onto the Antenna jack.

It is not recommended to operate this transceiver without an antenna connected.

- ❑ If you have a Speaker/Microphone, we recommend that it not be connected until you are familiar with the basic operation of the **EVX-531**. Refer to page 9 for more information about Speaker/Microphone usage.

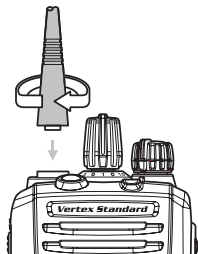

IMPORTANT NOTE

Water resistance of the transceiver (IP57: 1 meter / 30 minutes) is assured only when the following conditions:

- ❑ Battery pack is attached to the transceiver;
- ❑ Antenna is connected to the antenna jack;
- ❑ and **MIC/SP** cap is installed in the **MIC/SP** jack.
- ❑ Use of a speaker microphone in the accessory connector negates the IP57 rating.

Operation Quick Start

- ❑ Turn the top panel's **VOL/PWR** knob clockwise to turn the radio on.

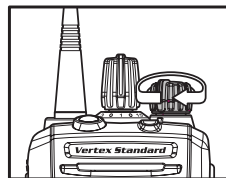

- ❑ Turn the top panel's **CH** Selector knob to choose the desired operating channel. The radio announces the channel number, if the Channel Announcement Feature is enabled via the clone editor software.

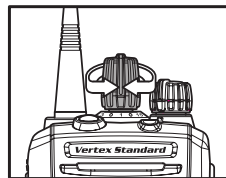

- ❑ If you want to select the operating channel from a different Channel Group, press (or press and hold) the Programmable key (assigned to the "**GROUP CHANGE**" function) to change desired Channel Group before selecting the operating channel.

OPERATION

- ❑ Rotate the **VOL/PWR** knob to set the volume level. If no signal is present on the analog channel, press and hold in the **SIDE-1** button (under the **PTT** switch) more than 2 seconds; background noise will now be heard, and you may use this to set the **VOL/PWR** knob for the

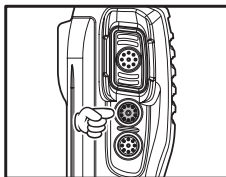
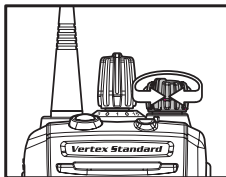

- desired audio level. Press and hold the **SIDE-1** button more than 2 seconds (or press the **SIDE-1** button *twice*) to quiet the noise and resume normal (quiet) monitoring.

- ❑ To transmit, monitor the channel and make sure it is clear.

Press and hold the **PTT** switch. Speak into the microphone area of the front panel grille in a normal voice level. To return to the Receive mode, release the **PTT** switch.

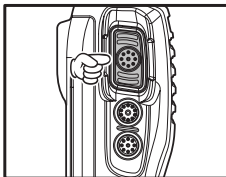

- ❑ Press the (Orange) **TOP SEL** key or **SIDE-2** button to activate one of the pre-programmed functions which may have been enabled at the time of programming by the dealer. See the next section for details regarding feature availability for this radio.

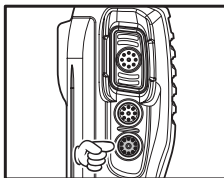
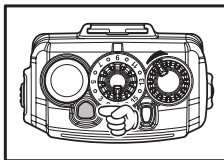

- ❑ If a Speaker/Microphone is available, remove the plastic cap and its two mounting screws from the right side of the transceiver, then align the connector of the Speaker/Microphone

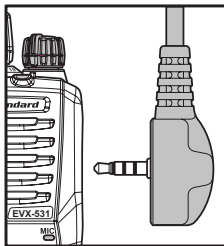

on the radio; secure the connector pin using the screws supplied with the Speaker/Microphone. Hold the speaker grille up next to your ear while receiving. To transmit, press the **PTT** switch on the Speaker/Microphone, just as you would on

OPERATION

the main transceiver's body, and speak into the microphone on a normal voice level.

Note 1): *Save the original plastic cap and its mounting screws. They should be reinstalled when not using the Speaker/Microphone.*

2) *When you press the PTT switch on the Speaker/Microphone, it disables the internal microphone, and vice versa.*

- ❑ If the BCLO (Busy Channel Lockout) feature has been programmed on an **analog channel**, the radio will not transmit when a carrier is present. Instead, the radio will generate short beep three times. Release the **PTT** switch and wait for the channel to be clear of activity.
- ❑ If the BTLO (Busy Tone Lockout) feature has been programmed on an **analog channel** or CCLO (Color Code Lockout) feature has been programmed on a **digital channel**, the radio can transmit only when there is no carrier being received or when the carrier being received includes the correct tone (CTCSS tone or DCS code) on an **analog channel** or correct code on a **digital channel**.

Automatic Time-Out Timer

If the selected channel has been programmed for automatic time-out, you must limit the length of each transmission. While transmitting, a beep will sound 10 seconds before time-out. Another beep will sound just before the deadline; the top panel's red LED ("TX" indicator) will disappear and transmission will cease soon thereafter. To resume transmitting, you must release the **PTT** switch and wait for the "penalty timer" to expire.

ADVANCED OPERATION

Programmable Key Functions

The **EVX-531** provides the programmable **TOP SEL**, **SIDE-1**, and **SIDE-2** function keys.

These Programmable Function keys can be customized, via programming by your Vertex Standard dealer, to meet your communications/network requirements.

The possible Programmable key programming features are illustrated on the next page, and their functions are explained beginning after page 13. For further details, contact your Vertex Standard dealer.

In this chapter, the following icons are used to indicate features supported in either the “Analog” mode or “Digital” mode:

: Indicates a “Analog” mode only feature.

: Indicates a “Digital” mode only feature.

For features that are available in both “Analog” and “Digital” modes, no icon is shown.

For future reference, check the box next to each function that has been assigned to the Programmable key on your particular radio, and keep it handy.

ADVANCED OPERATION

FUNCTION	PROGRAMMABLE KEY (PRESS KEY / PRESS AND HOLD KEY)			FUNCTION	PROGRAMMABLE KEY (PRESS KEY / PRESS AND HOLD KEY)		
	TOP SEL	SIDE-1	SIDE-2		TOP SEL	SIDE-1	SIDE-2
None	/	/	/	Scan	/	/	/
Monitor	/	/	/	Group Scan	/	/	/
Monitor -Momentarily-	/—	/—	/—	Dual Watch	/	/	/
Low Power	/	/	/	FM Scan (Follow-Me Scan)	/	/	/
Privacy	/	/	/	TA Scan	/	/	/
SQL OFF	/	/	/	SCAN Set	/	/	/
SQL OFF -Momentarily-	/—	/—	/—	Talk Around (TA)	/	/	/
Beep Off	/	/	/	RESET	/	/	/
Whisper	/	/	/	Call 1	/	/	/
VOX	/	/	/	Call 2	/	/	/
VOX Anti-Trip	/	/	/	Call 3	/	/	/
Emergency	/—	/—	/—	Speed Dial	/	/	/
Lone Worker	/	/	/	Call	/	/	/
Group Change	/	/	/	TX Save Disable	/	/	/
PRI-2 Set	/	/	/	Lock	/	/	/
PRI-2 Disable	/	/	/				

ADVANCED OPERATION

Description of Operating Functions

MONITOR

Press (or press and hold) the assigned Programmable key to cancel any signaling features; the LED indicator will glow with a pre-defined color (Factory default: green).

MONITOR -MOMENTARILY-

Cancel any signaling features while pressing the assigned programmable key.

LOW POWER

Press (or press and hold) the assigned Programmable key to set the radio's transmitter to the "Low Power" mode, thus extending battery life; the LED indicator will glow with a pre-defined color. Press (or press and hold) the key again to return to "Normal" transmit power when in difficult terrain.

PRIVACY

Press (or press and hold) the assigned Programmable key to toggle the Privacy feature "On" and "Off".

The privacy feature initiates an encryption algorithm that will protect your communication from unauthorized eavesdropping.

SQL OFF

Press (or press and hold) the assigned programmable key to open the SQL to hear background noise (unmute the audio).

SQL OFF -MOMENTARILY-

Opens the SQL to hear background noise (unmute the audio) while pressing the assigned programmable key.

BEEP OFF

Press (or press and hold) the assigned Programmable key to disable the radio beeps and the channel announcement (if activated) temporarily. Again press (or press and hold) the assigned Programmable key to enable the radio beeps and the channel announcement.

WHISPER

Press (or press and hold) the assigned Programmable key to increase the microphone gain; thus you can speak in a low voice (whisper) temporarily. Again press (or press and hold) the assigned Programmable key to resume normal microphone gain.

ADVANCED OPERATION

VOX

Press (or press and hold) the assigned programmable key to turn the VOX function “On” or “Off”. When the VOX function is activated, the LED indicator will glow with a pre-defined color. You may disable the VOX function temporarily by pressing the **PTT** switch.

VOX ANTI-TRIP

Press (or press and hold) the assigned Programmable key to toggle the VOX Anti-Trip feature “On” and “Off”. When the VOX Anti-Trip feature is set to “On”, the transceiver does not activate the transmitter section from the receiver audio and own beep sound.

EMERGENCY

The **EVX-531** includes an “Emergency” feature in either analog or digital modes, which may be useful for alerting another party monitoring on the same frequency as your transceiver’s channel.

Press the assigned Programmable key to initiate an emergency call on the pre-defined channel. For further details contact your Vertex Standard dealer.

LONE WORKER

Press (or press and hold) the assigned Programmable key to toggle the Lone Worker feature “On” and “Off”.

The Lone Worker feature is designed to emit an emergency alarm for 30 seconds when the Lone Worker Timer (programmed by your Vertex Standard dealer) has expired. If the user does not reset the timer by pressing the **PTT** switch, the radio switches to the Emergency mode.

GROUP CHANGE

The **EVX-531** has two Channel Groups (Group 1 and Group 2).

Press (or press and hold) the assigned Programmable key to change the Channel Group to the opposite Group. When there is a radio in the Group 2, the LED indicator will blink with a pre-defined color. Once the desired Group is reached, rotate the **CH** Selector knob to select the desired channel within the selected Group.

ADVANCED OPERATION

PRI-2 SET

Press (or press and hold) the assigned programmable key to toggle the current channel to the priority channel 2 “enable” and “disable”.

PRI-2 DISABLE

Press (or press and hold) the assigned programmable key to disable the priority channel 2 of the group temporarily.

SCAN

The Scanning feature is used to monitor multiple signals programmed into the transceiver. While scanning, the transceiver will check each channel for the presence of a signal, and will stop on a channel if a signal is present. **EVX-531** can scan both digital and analog frequency programmed channels simultaneously.

To activate scanning:

- Press (or press and hold) the assigned Programmable key to activate scanning: the LED indicator will glow with a pre-defined color.
- The scanner will search the channels of each channel, looking for active ones; it will pause

each time it finds a channel on which someone is speaking.

- Press (or press and hold) the assigned Programmable key again to disable scanning. Operation will revert to the programmed revert channel.

Note: Your dealer may have programmed your radio to stay on one of the following channels if you press the **PTT** switch during scanning pause:

- “Scan Pause” channel (“Talk Back”)
- “Last Busy” channel
- “Priority-2” channel
- “User Programmed” channel (“Select Channel”)
- The channel which defined in the **CH** Selector knob.

GROUP SCAN

The Scanning feature is used to monitor multiple channels programmed into the transceiver. While scanning, the transceiver will check each channel of the programmed group for the presence of the signal, and will stop on a channel if a signal is present.

Press (or press and hold) the assigned programmable key to activate the scanning on the selected groups.

ADVANCED OPERATION

DUAL WATCH

The Dual Watch feature is similar to the SCAN feature, except that only two channels are monitored:

- The current operating channel; and
- The Priority-2 channel.

To activate Dual Watch:

- Press (or press and hold) the assigned Programmable key.
- The scanner will search the two channels; it will pause each time it finds a channel on which someone is speaking.

To stop Dual Watch:

- Press (or press and hold) the assigned Programmable key.
- Operation will revert to the “Dual Watch Revert” channel.

FM SCAN (FOLLOW-ME SCAN)

The FM Scan feature checks a User-assigned Priority Channel regularly as you scan other channels. Thus, if only Channels 1, 3, and 5 (of the 8 available channels) are designated for “Scanning”, the user may nonetheless assign Channel 2 as the “User-assigned” Priority Channel via the FM Scan.

To activate FM Scan, first select the channel you want to designate as the “User-Assigned Priority Channel” and press (or press and hold) the assigned programmable key. Then rotate the **CH** Selector knob to recall to the “Scanning Start” channel which has been programmed by your dealer to activate the scanner. When the scanner stops on an “Active” channel, the User-assigned Priority Channel will automatically be checked every few seconds; if activity is found on the User-assigned Priority Channel, the radio will switch between it and the Dealer-Assigned Priority Channel, if any.

ADVANCED OPERATION

TA SCAN

Press (or press and hold) the assigned Programmable key to toggle the TA (Talk Around) scan feature “On” and “Off”.

While TA scan is proceeding, the transceiver will search both the transmit and receive frequencies. When a signal is encountered on the receive frequency, the **EVX-531** will pause until the signal disappears. When a signal is encountered on the transmit frequency, the transceiver will check for activity on the receive frequency every few seconds (interval programmed by your Vertex Standard dealer).

Note: The TA Scan feature does not activate on the Simplex Channel.

SCAN SET

Press (or press and hold) the assigned Programmable key to add/delete the current channel to/from your scanning list.

When the scanner is stopped, you may remove the channel from the scan list temporarily by pressing (or press and holding) this key.

TALK AROUND (TA)

Press (or press and hold) the assigned Programmable key to activate the Talk Around feature when you are operating on duplex channel systems (separate receive and transmit frequencies, utilizing a “repeater” station). When the Talk Around feature is activated, the LED indicator will glow with a pre-defined color.

The Talk Around feature allows you to bypass the repeater station and talk directly to a station that is nearby. This feature has no effect when you are operating on “simplex” channels, where the receive and transmit frequencies are already the same.

Note that your dealer may have mode provision for “Talk Around” channels by programming “repeater” and “Talk Around” frequencies on two adjacent channels. If so, the key may be used for one of the other Pre-Programmed Functions.

Note: The Talk Around feature does not activate on the Simplex Channel.

ADVANCED OPERATION

RESET

Press (or press and hold) the assigned programmable key to reset the RFC (Ready for Communication) condition.

CALL 1 TO CALL 3

Press (or press and hold) the assigned Programmable key to send a pre-defined 2-tone Sequential Tone Group (on an *analog channel*) or a pre-defined Digital Contact List (on a *digital channel*).

SPEED DIAL

Press (or press and hold) the assigned Programmable key to prepare the Speed Dial function. Press the **PTT** switch within 5 seconds of releasing the key to send a pre-defined DTMF tone.

CALL

Press (or press and hold) the assigned programmable key to send a 2-tone sequential tone.

TX SAVE DISABLE

Press (or press and hold) the assigned Programmable key to disable the Transmit Battery Saver, if you are operating in a location where high power is almost always needed.

The Transmit Battery Saver helps extend battery life by reducing transmit power when a very strong signal from an apparently nearby station is being received. Under some circumstances, though, your hand-held radio may not be heard well at the other end of the communication path, and high power may be necessary at all times.

Lock

Press (or press and hold) the assigned Programmable key to lock the **CH** Selector knob, Programmable keys, and **PTT** switch. The precise lockout configuration is programmed by your Vertex Standard Dealer.

LOCK

In order to prevent accidental channel change or inadvertent transmission, various aspects of the **CH** Selector knob, Programmable keys, and **PTT** switch may be locked.

The precise lockout configuration is programmed by your Dealer.

To locked out the key locking, turn the radio off. Now, press and hold the **PTT** and **SIDE-2** key while turning the radio on again.

To cancel locking, repeat this process.

ARTS™ (AUTO RANGE TRANSPOND SYSTEM)

This system is designed to inform you when you and another ARTS™-equipped station are within communication range.

During ARTS™ operation, when the radio receives an incoming ARTS™ signal, a short beep will sound. If you move out of range for more than two minutes, your radio senses that no signal has been received; a short triple-beep will sound. If you subsequently move back into communication range, as soon as the other station transmits, a short beep will sound again.

ARTSII™ (AUTO RANGE TRANSPOND SYSTEM)

The ARTSII™ system is enhanced feature of the ARTS™ which can be finding out the communication range of the radio individually by using the MDC-1200® Encode/Decoder.

Note: EVX-531 will be able to be decoded by display radios with ARTSII™ enabled, but will not be able to decode the other radios encode signals.

OPTIONAL ACCESSORIES

FNB-V133LI-UNI	7.4V, 1380 mAh Li-Ion Battery Pack	CLIP-20	Belt Clip
FNB-V134LI-UNI	7.4V, 2300 mAh Li-Ion Battery Pack	CE142	PC Programming Software
CD-58	Desktop Charger	FIF-12	USB Programming Interface
PA-55	AC Adapter	CT-106	Connection Cable for FIF-12
MH-360S	Compact Speaker Microphone	CT-27	Radio to Radio Cloning Cable
MH-450S	Speaker Microphone		
MH-37A4B	Earpiece Microphone		
MH-66A4B	Submersible Speaker Microphone		
MH-81A4B	Over-the-head VOX Compatible Headset		
ATV-16A	VHF Antenna (136-150 MHz)		
ATV-16B	VHF Antenna (150-162 MHz)		
ATV-16C	VHF Antenna (162-174 MHz)		
ATV-16XL	VHF Antenna (Untuned)		
ATU-16B	UHF Antenna (400-420 MHz)		
ATU-16C	UHF Antenna (420-450 MHz)		
ATU-16D	UHF Antenna (450-470 MHz)		
ATU-16F	UHF Antenna (470-520 MHz)		
ATU-16BS	UHF Stubby Antenna (400-430 MHz)		
ATU-16DS	UHF Stubby Antenna (450-490 MHz)		
CN-2A	Antenna Adapter		

Availability of accessories may vary; some accessories are supplied standard per local requirements, others may be unavailable in some regions. Check with your Vertex Standard Dealer for changes to this list.

The AMBE+2™ voice coding Technology embodied in this product is protected by intellectual property rights including patent rights, copyrights and trade secrets of Digital Voice Systems, Inc. This voice coding Technology is licensed solely for use within this Communications Equipment. The user of this Technology is explicitly prohibited from attempting to decompile, reverse engineer, or disassemble the Object Code, or in any other way convert the Object Code into a human-readable form.

U.S. Pat. Nos. #5,870,405, #5,826,222, #5,754,974, #5,701,390, #5,715,365, #5,649,050, #5,630,011, #5,581,656, #5,517,511, #5,491,772, #5,247,579, #5,226,084 and #5,195,166.

Part 15.21: Changes or modifications to this device not expressly approved by Vertex Standard could void the user's authorization to operate this device.



Vertex Standard LMR, Inc.



Copyright 2013
Vertex Standard LMR, Inc.
All rights reserved.

No portion of this manual
may be reproduced
without the permission of
Vertex Standard LMR, Inc.